

MONARCHY BALLROOM HANG POINTS

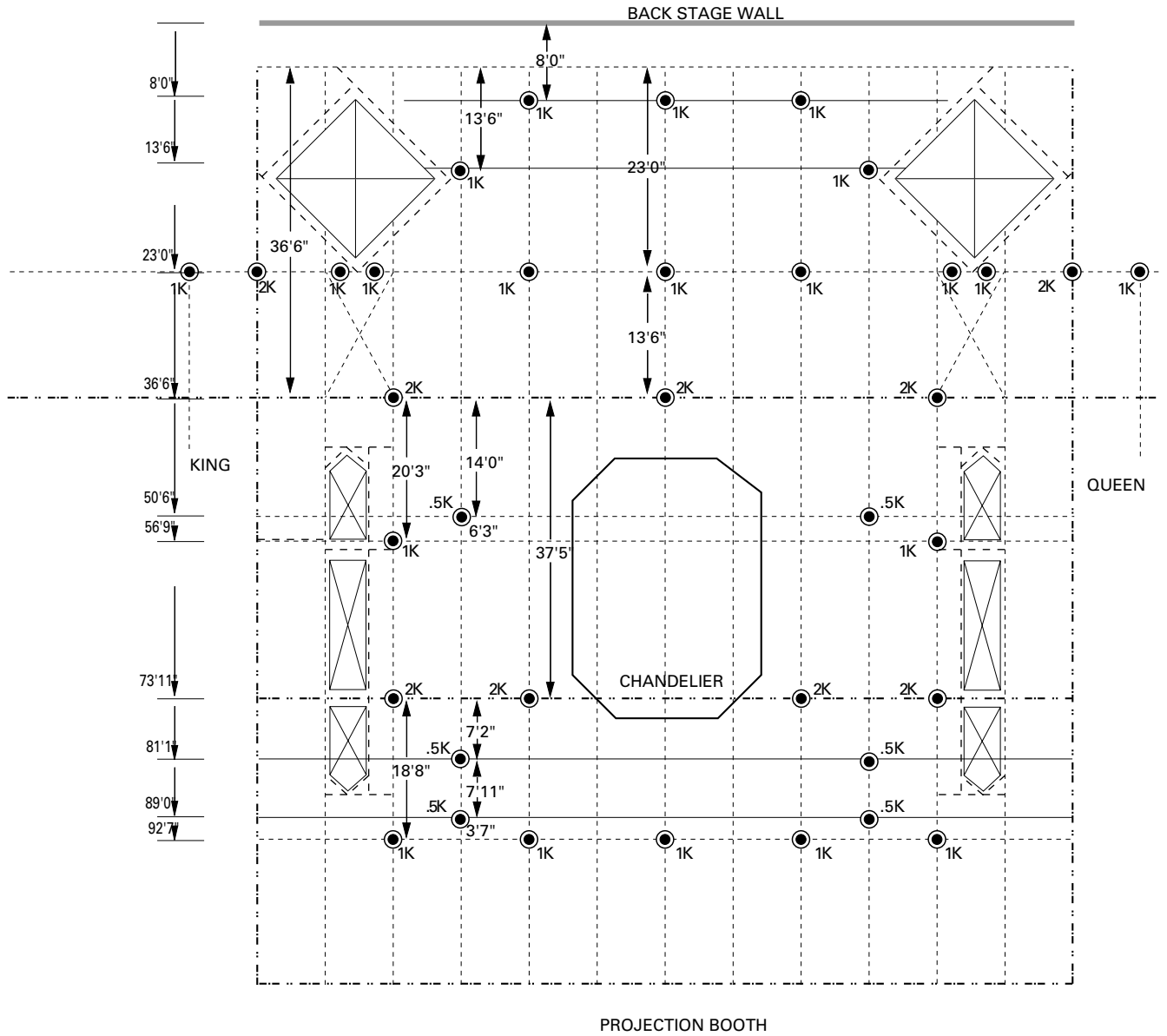

HILTON WAIKOLOA VILLAGE
Function and Meeting Space

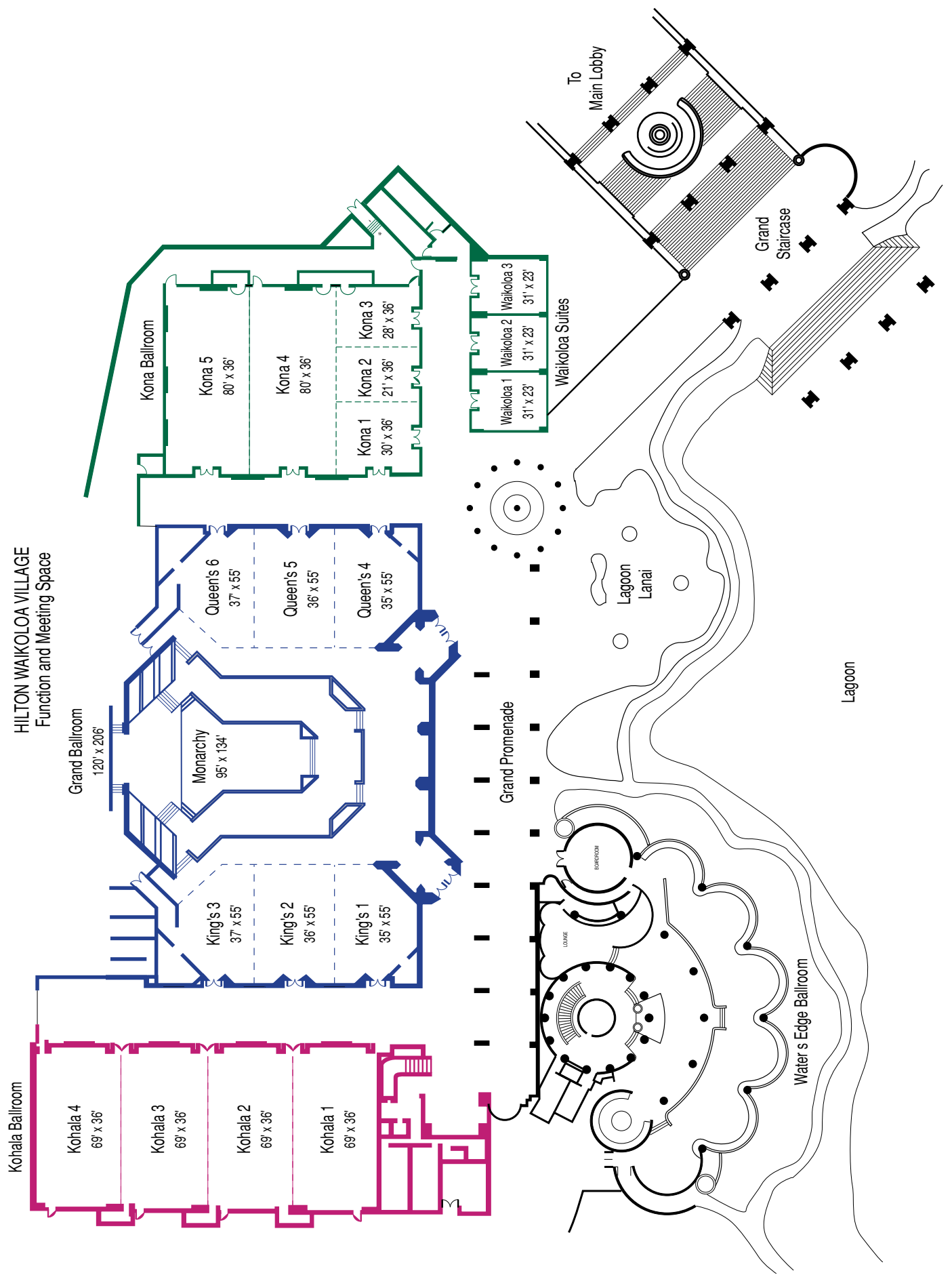

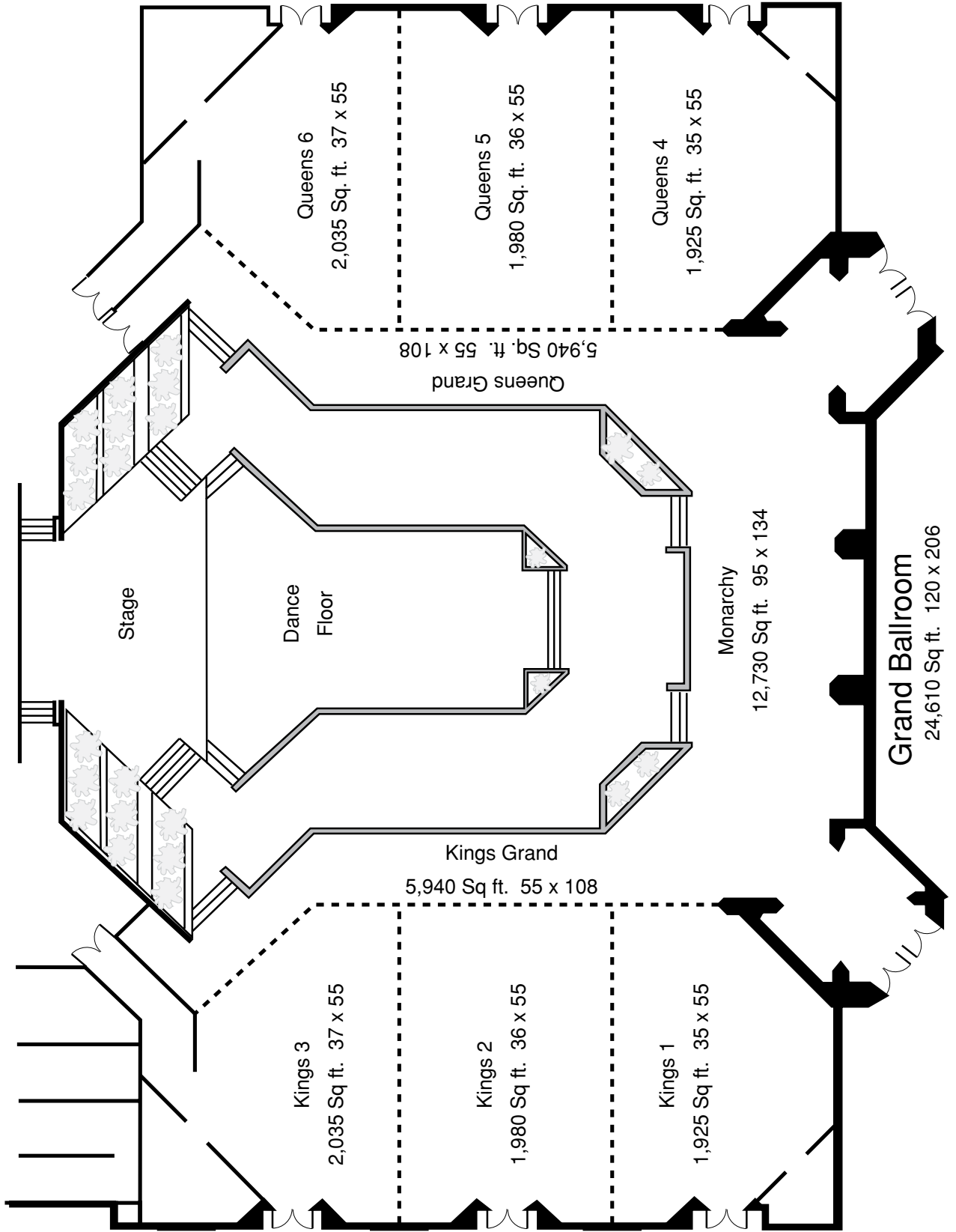

GRAND BALLROOM STAGE DIMENSIONS

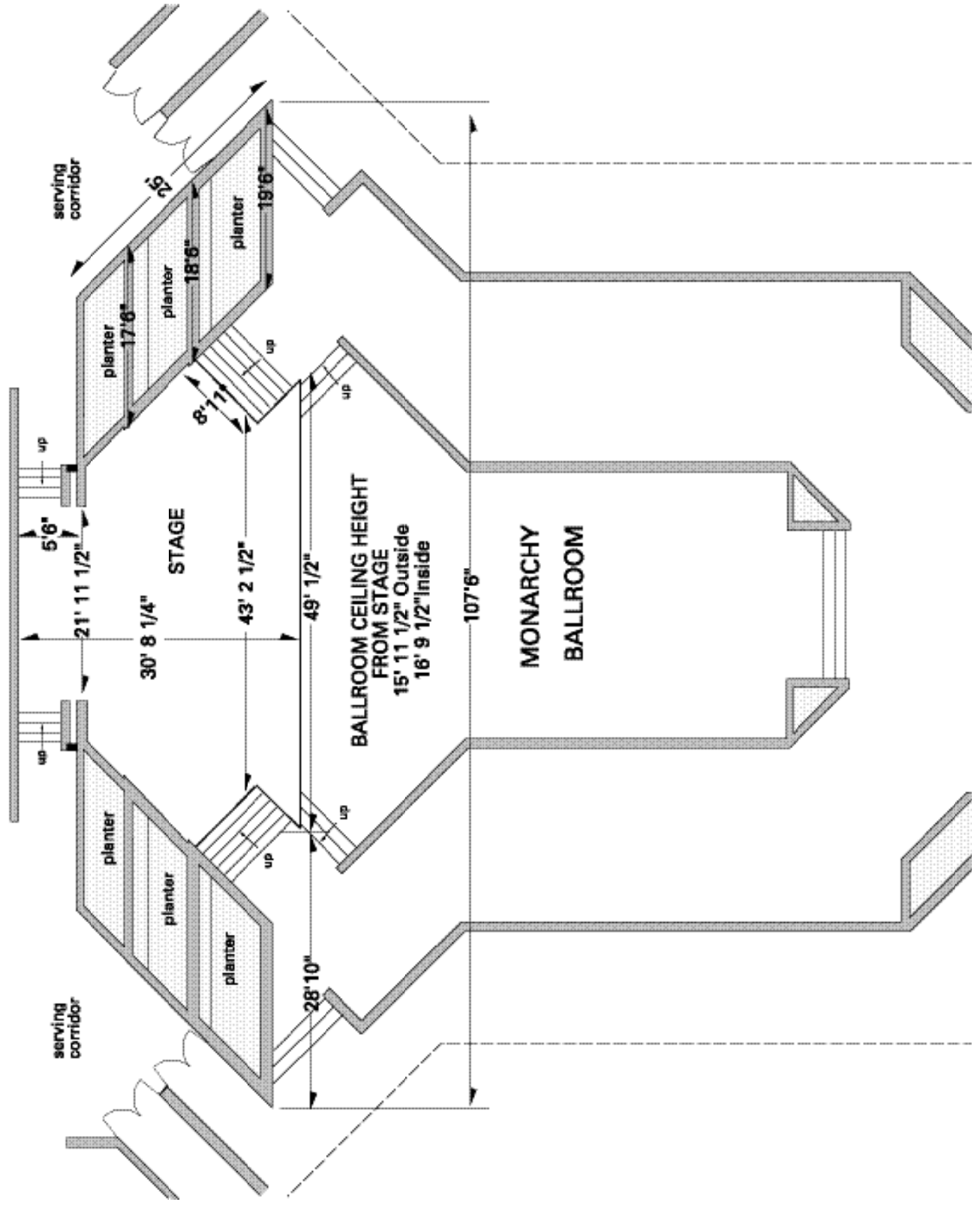

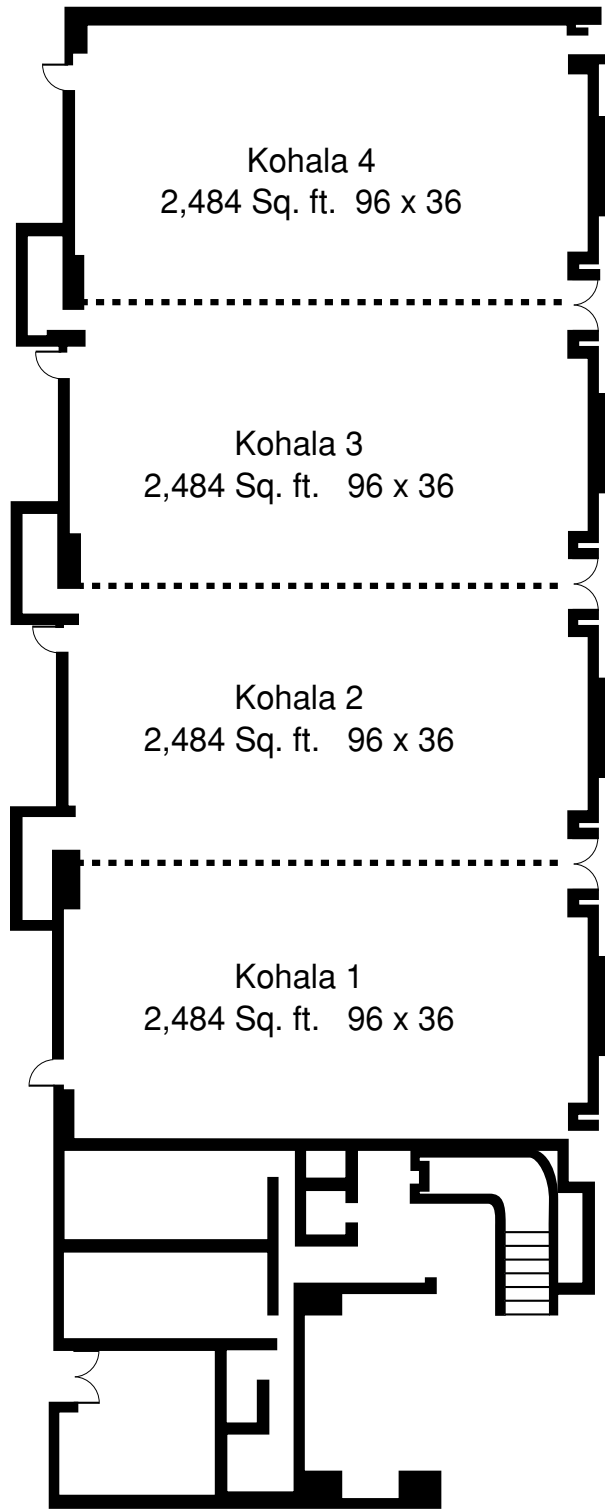

Kohala Ballroom

9,936 Sq. ft. 70 x 144

Kohala 4
2,484 Sq. ft. 96 x 36

Kohala 3
2,484 Sq. ft. 96 x 36

Kohala 2
2,484 Sq. ft. 96 x 36

Kohala 1
2,484 Sq. ft. 96 x 36

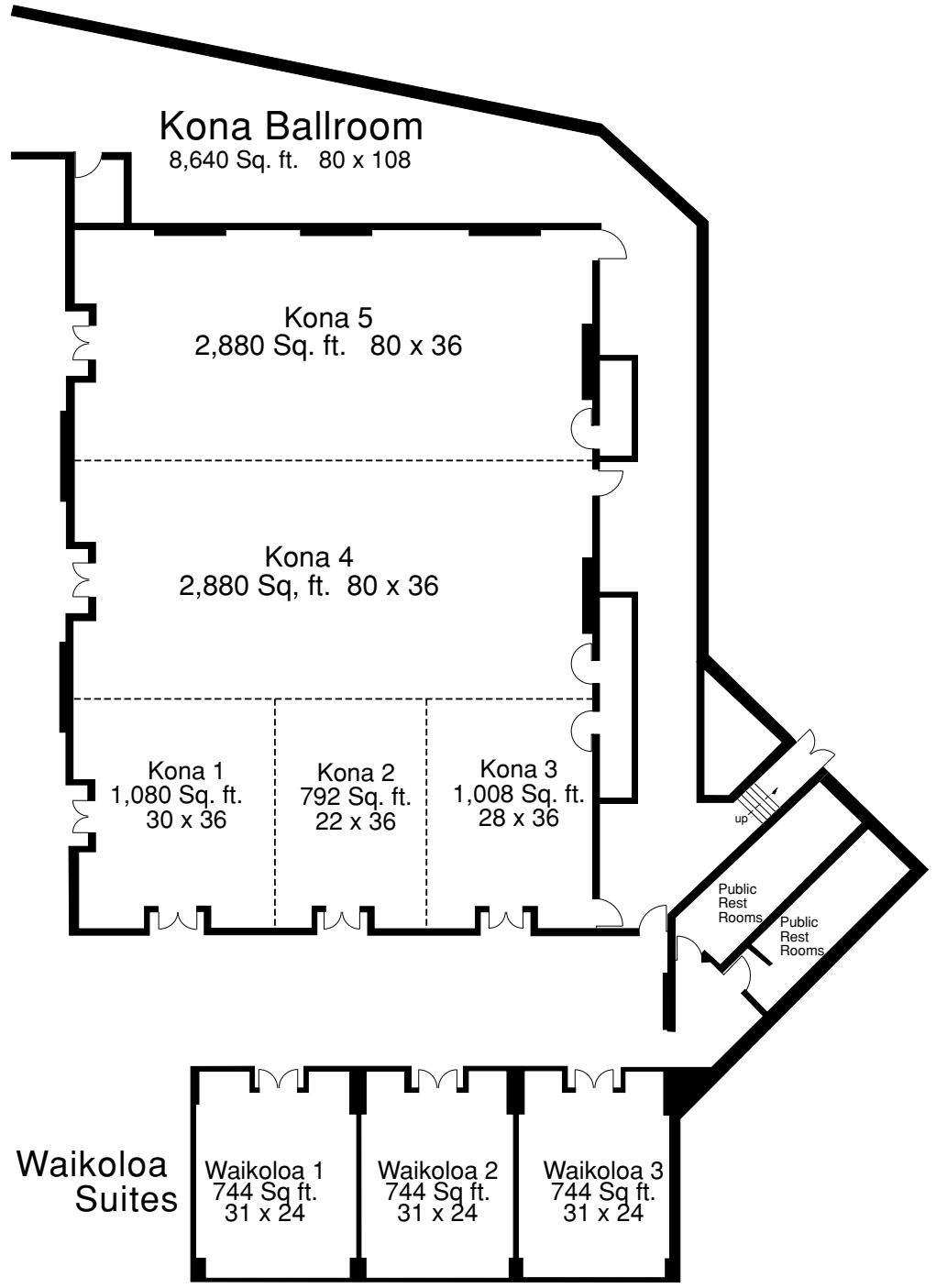

Kona Ballroom

8,640 Sq. ft. 80 x 108

Kona 5
2,880 Sq. ft. 80 x 36

Kona 4
2,880 Sq. ft. 80 x 36

Kona 1
1,080 Sq. ft.
30 x 36

Kona 2
792 Sq. ft.
22 x 36

Kona 3
1,008 Sq. ft.
28 x 36

up

Public Rest Rooms

Public Rest Rooms

Waikoloa Suites

Waikoloa 1
744 Sq. ft.
31 x 24

Waikoloa 2
744 Sq. ft.
31 x 24

Waikoloa 3
744 Sq. ft.
31 x 24

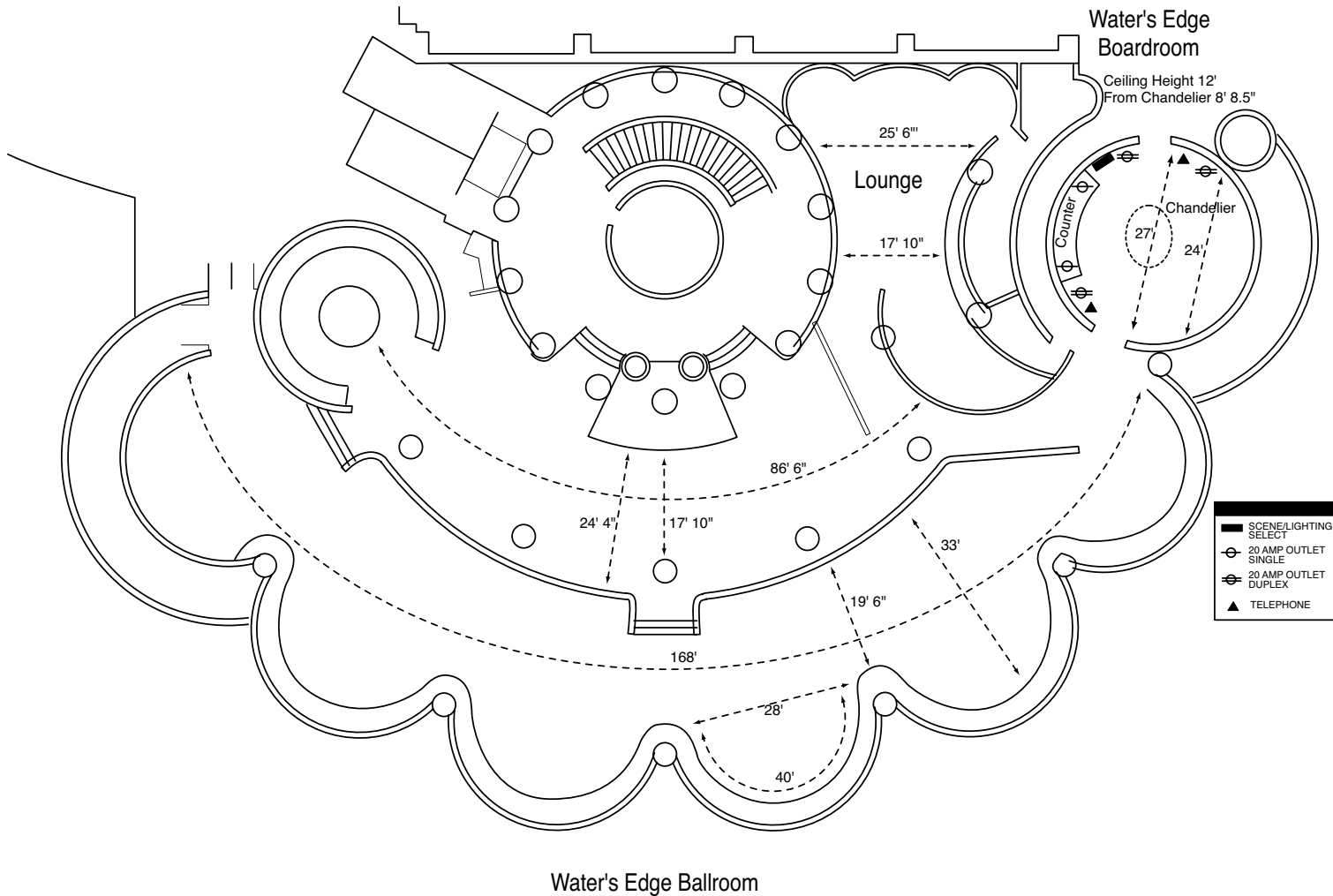

Kona Ballroom

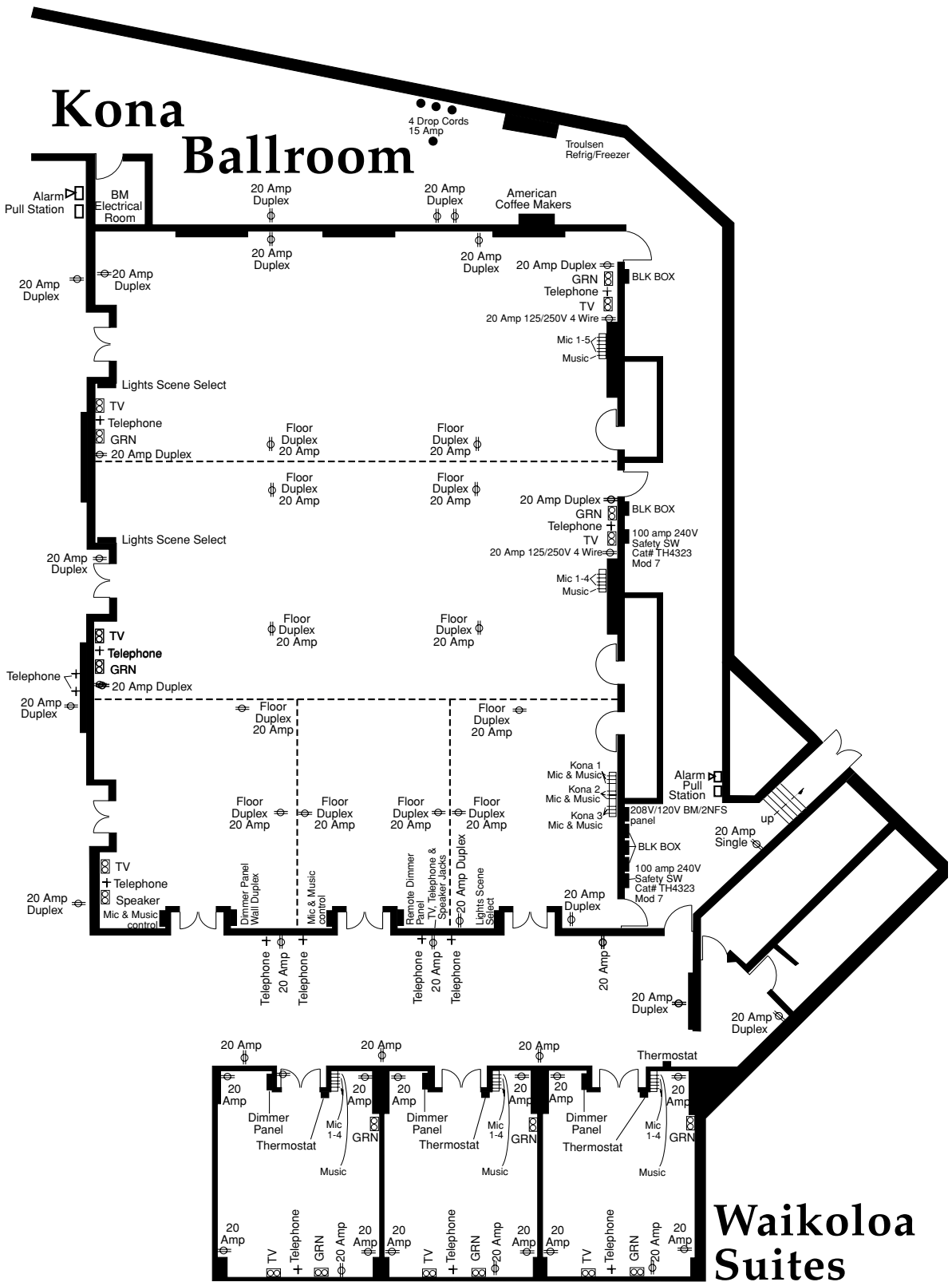

Waikoloa Suites

Kohala Ballroom Electrical

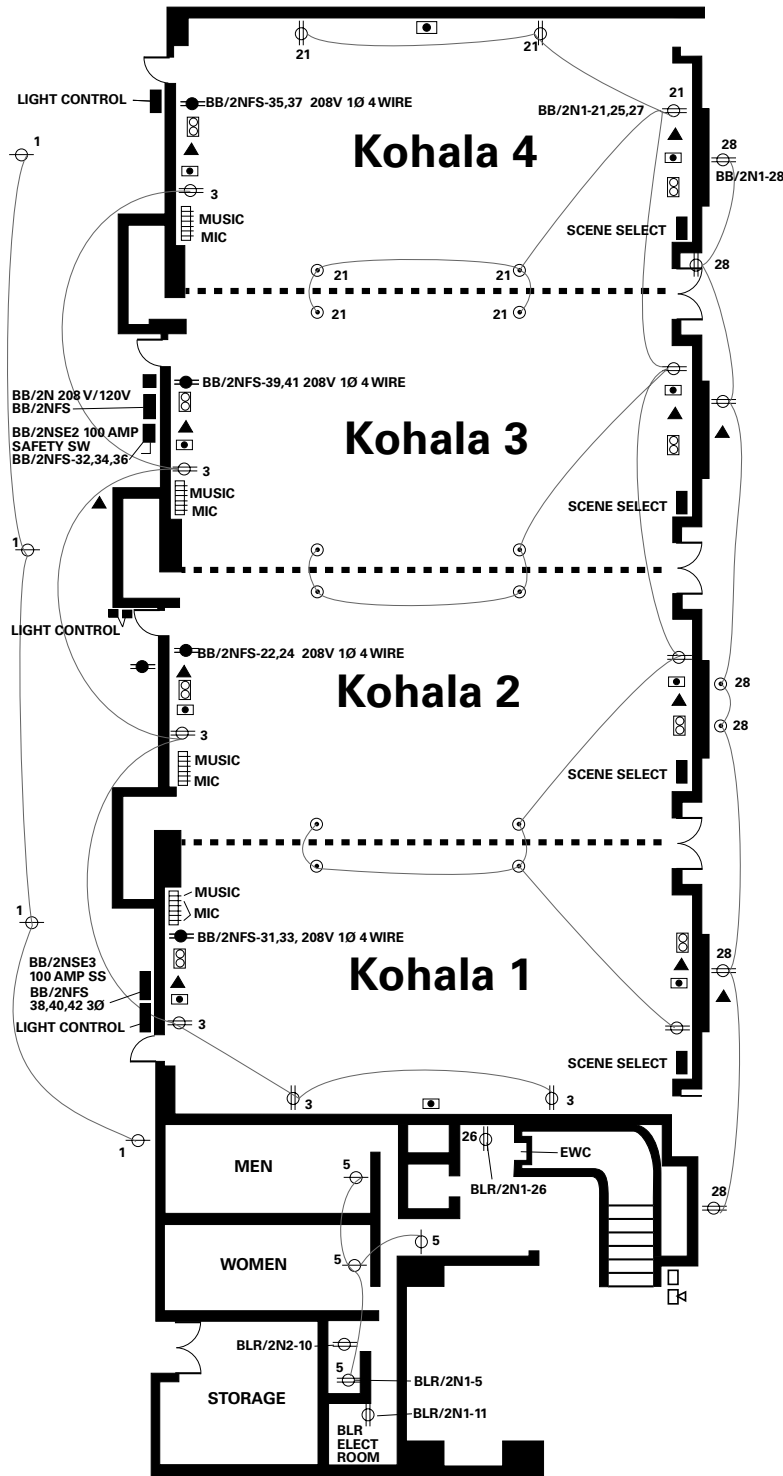

KEY	
	20 AMP OUTLET SINGLE
	20 AMP OUTLET DUPLEX
28	CIRCUIT #
	20 AMP FLOOR OUTLET
	20 Amp/208V 1Ø 4 wire
	TV
	TELEPHONE
	MIC & MUSIC CONTROLS
	MIC OUTLET
	FIRE ALARM
	PULL STATION

MONARCHY CAT WALK/CONTROL ROOM

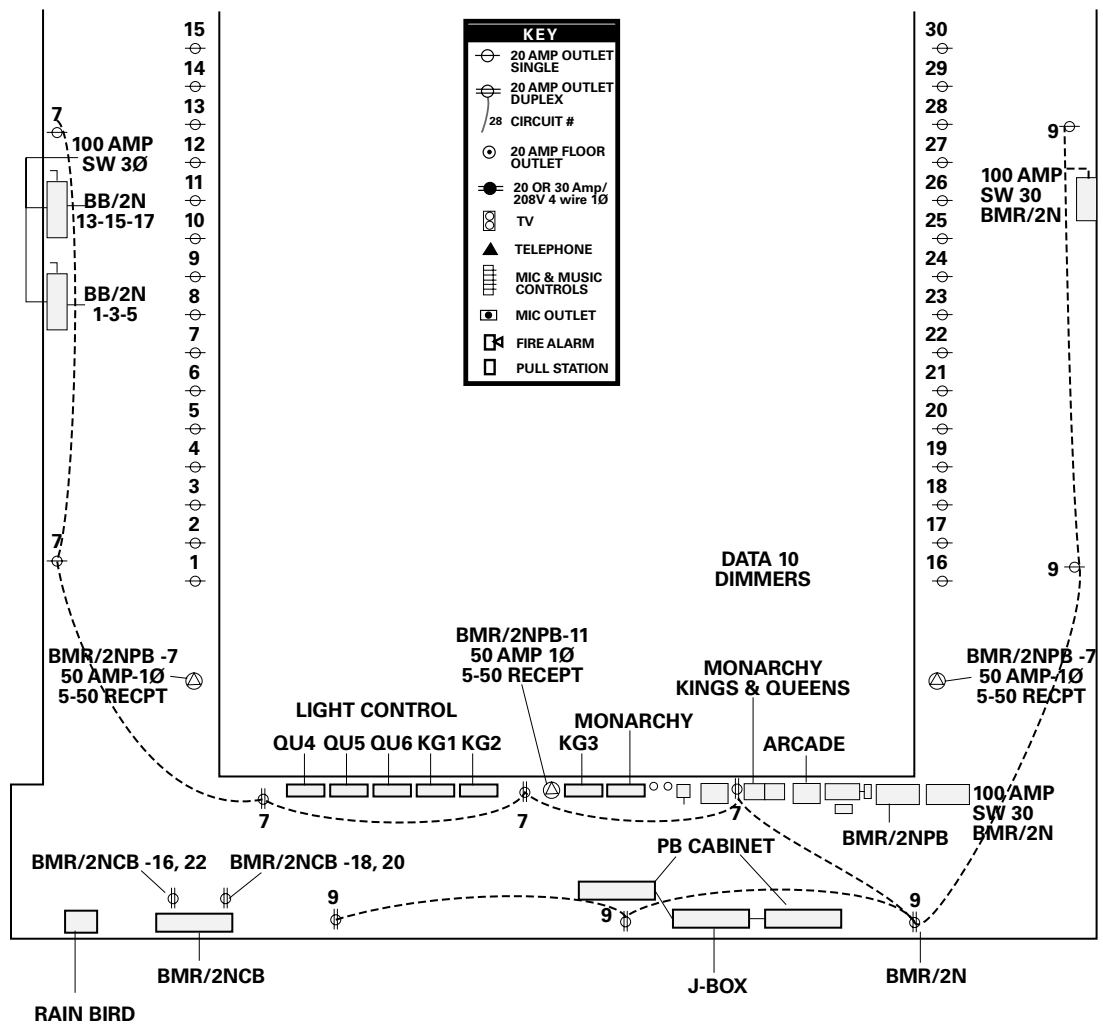

Kohala Ballroom

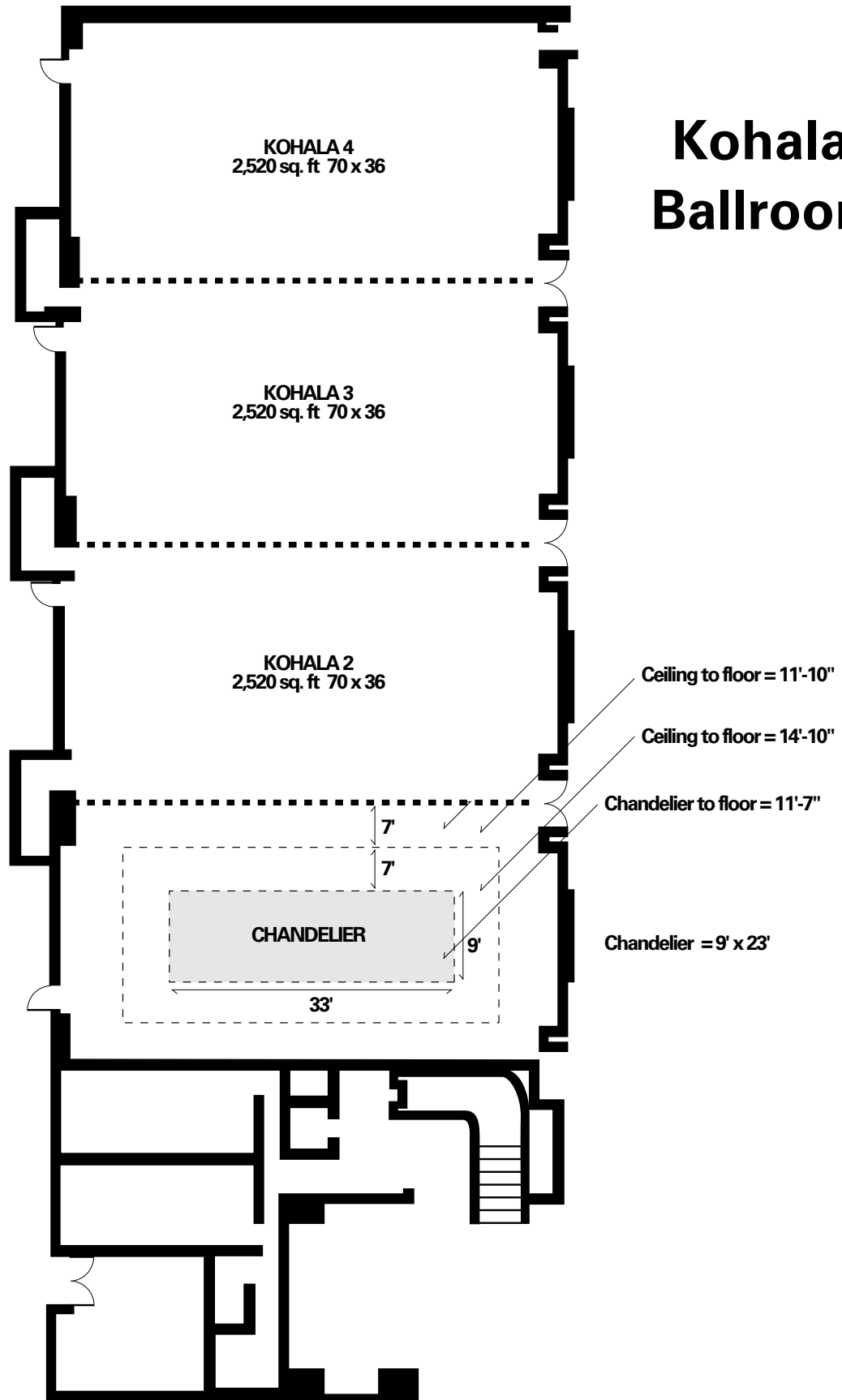

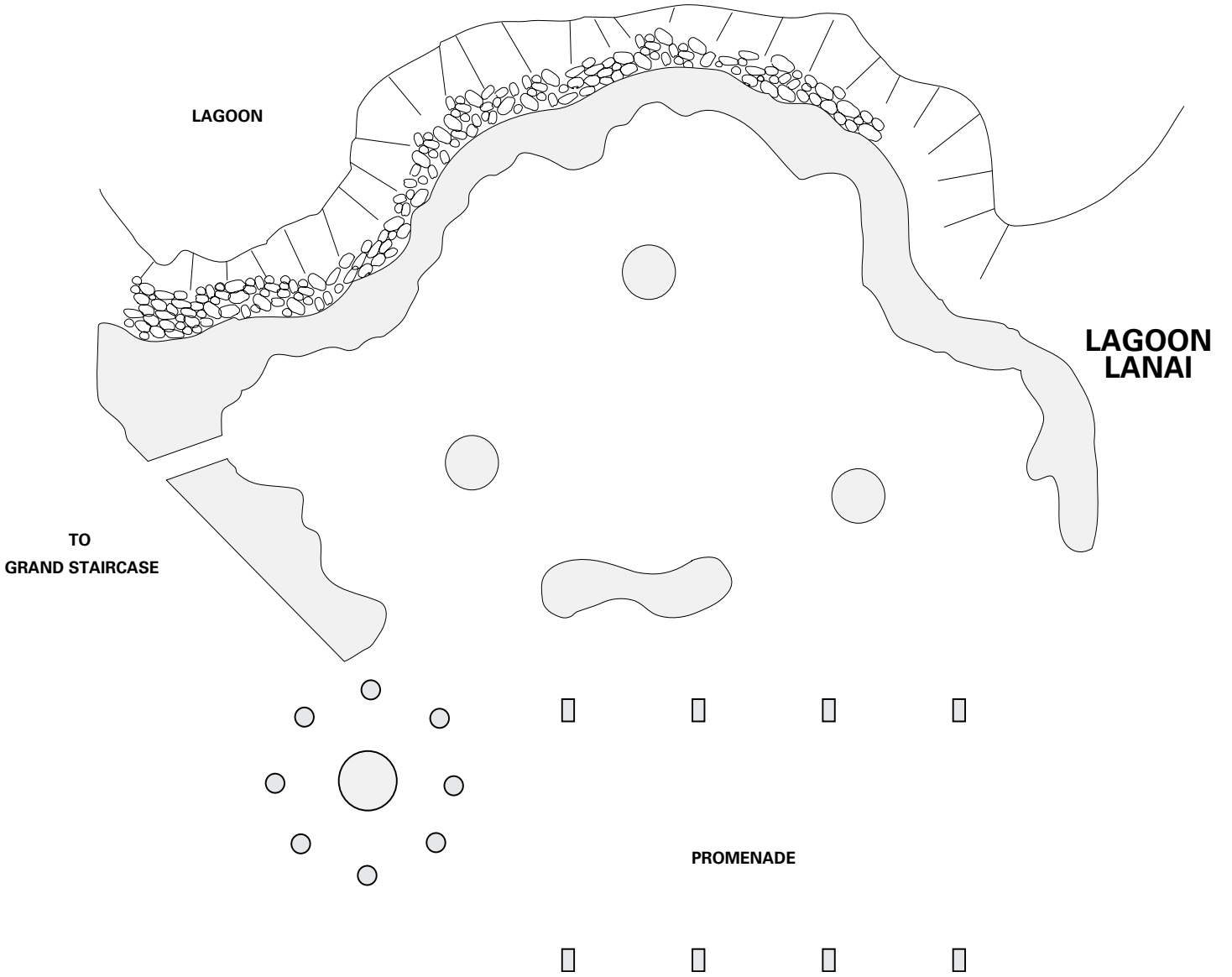

Kamehameha Court

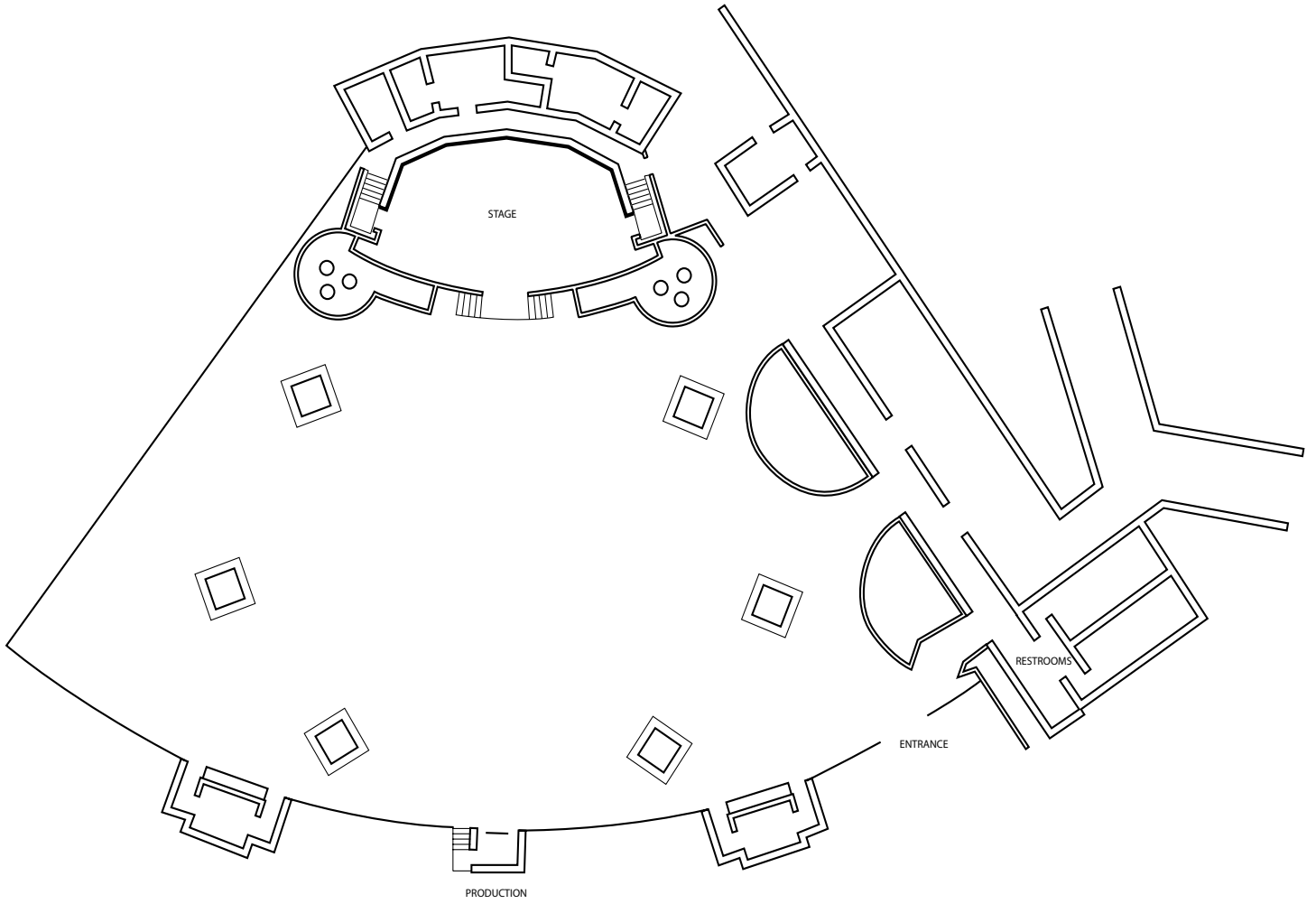

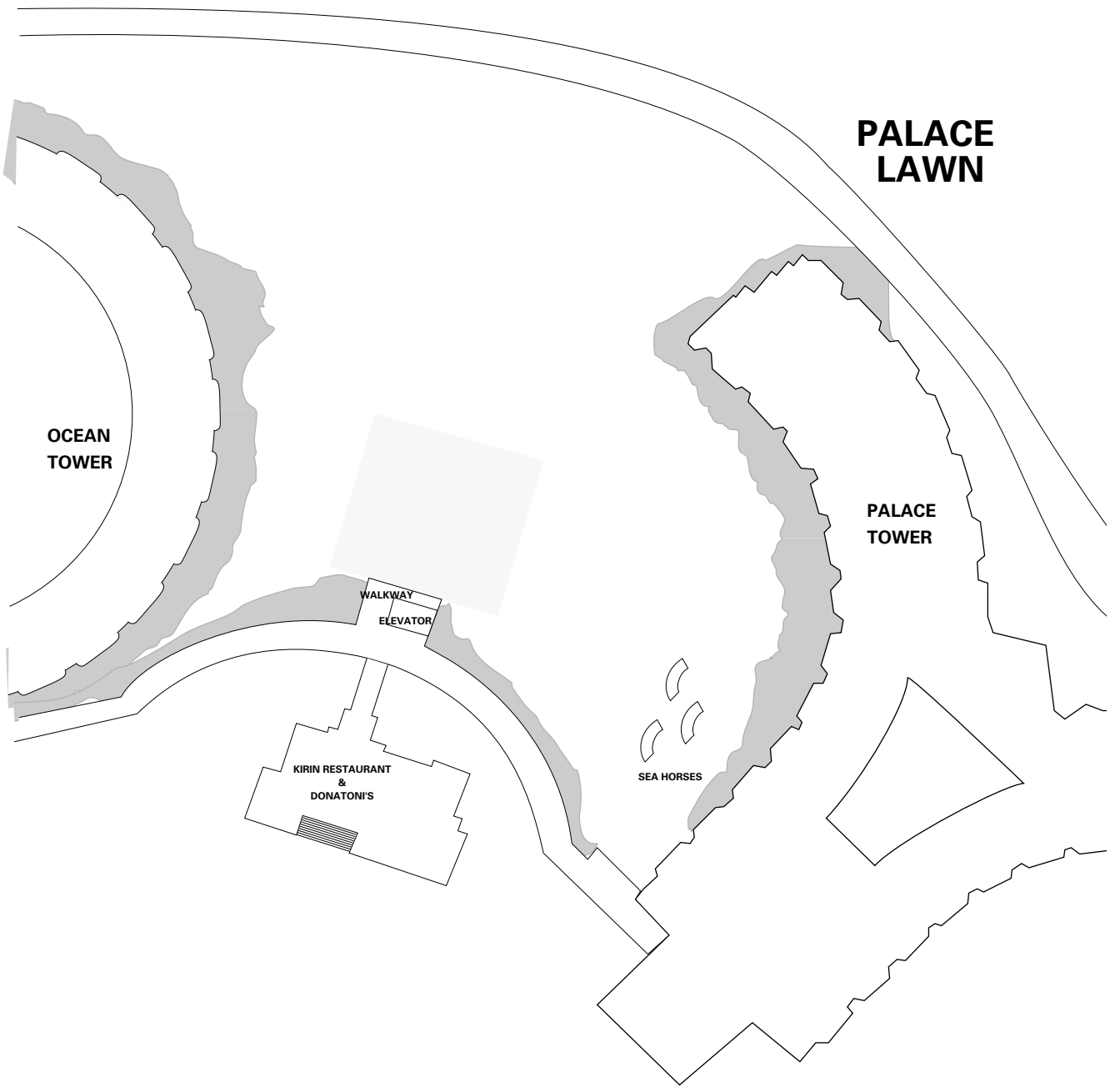

OCEAN
TOWER

PALACE
LAWN

PALACE
TOWER

WALKWAY
ELEVATOR

KIRIN RESTAURANT
&
DONATONI'S

SEA HORSES

GRAND STAIRCASE

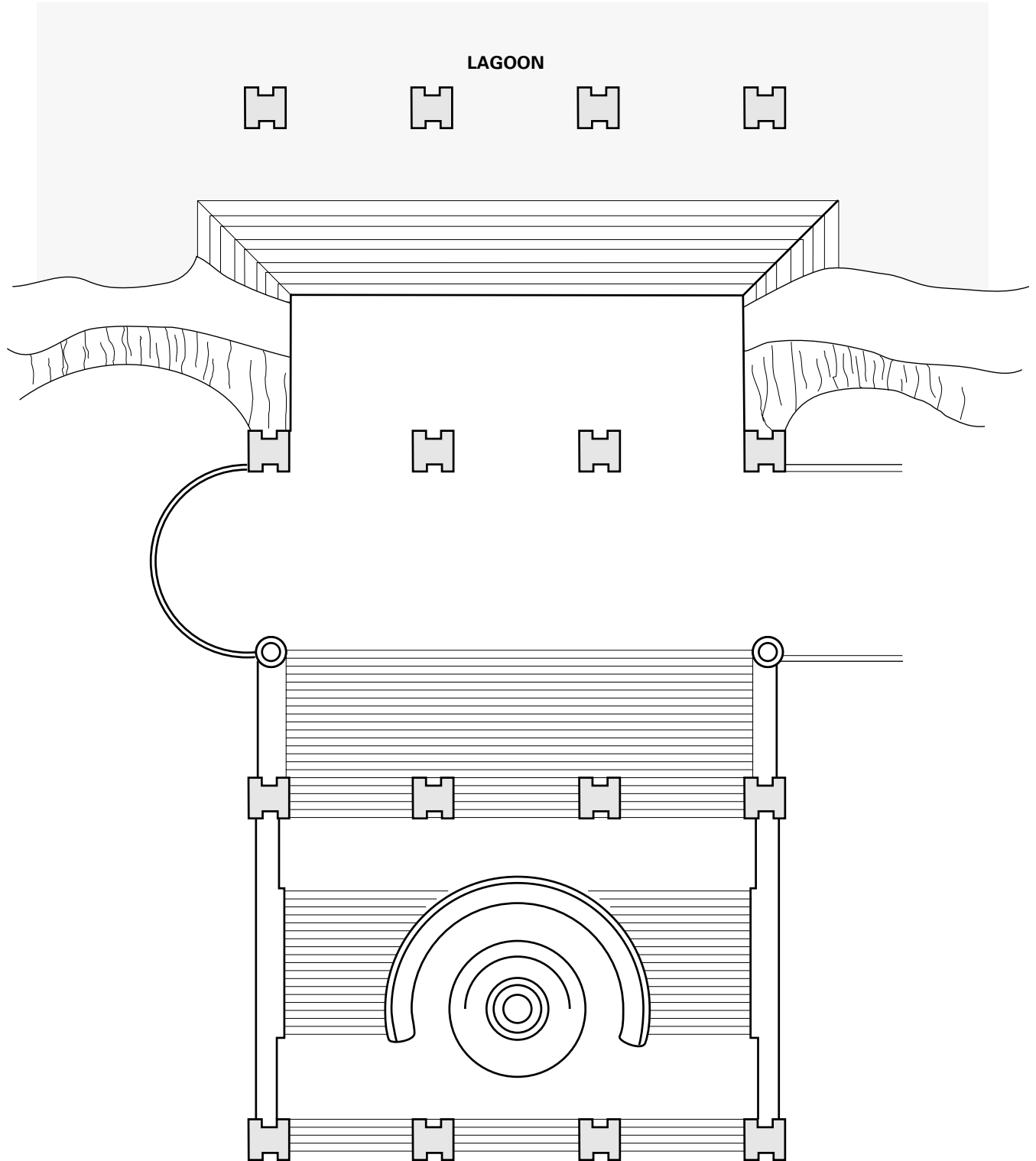

GF1 BLR/2N4 - 36, 38, 40, 41 & 42

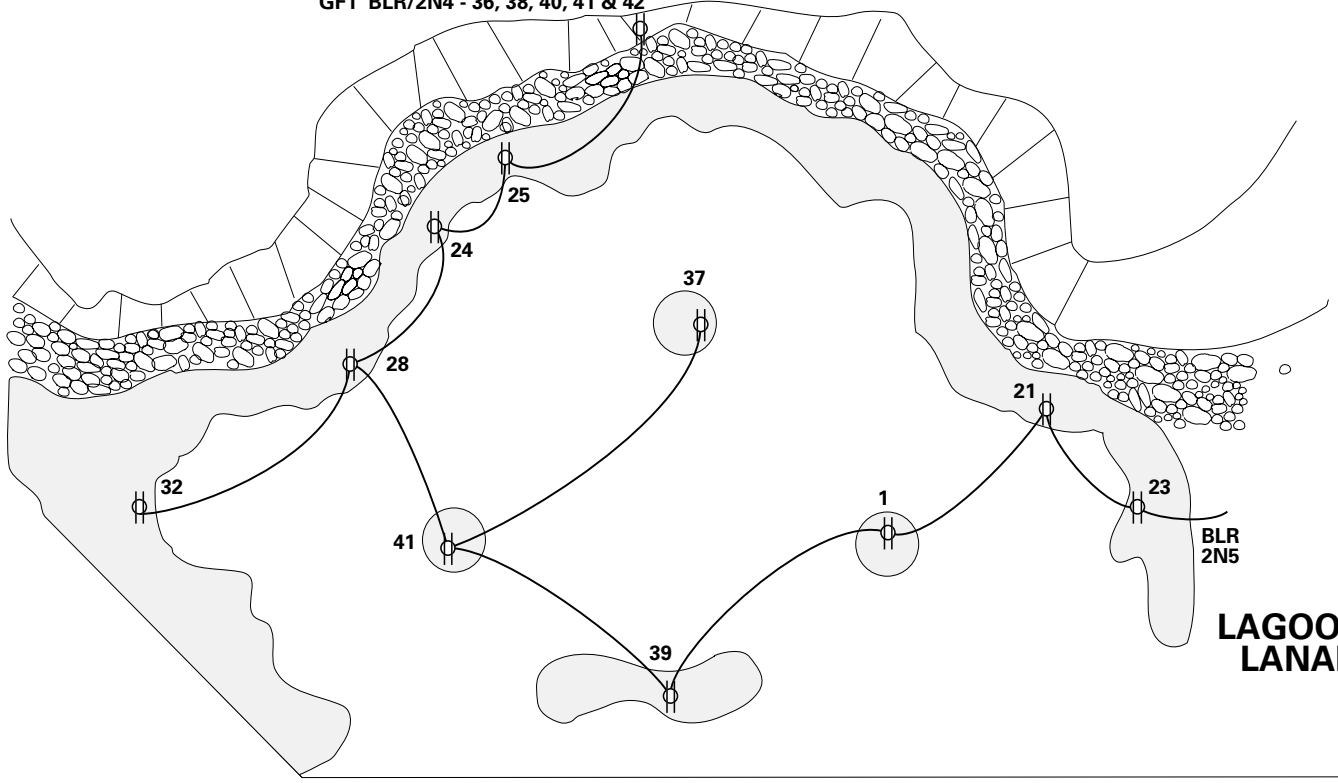

LAGOON LANAI

